

Varenummer: 2302003202
Beskrivelse: E+G Høj Fingermetrik
B.259/30 B-M8

Mål

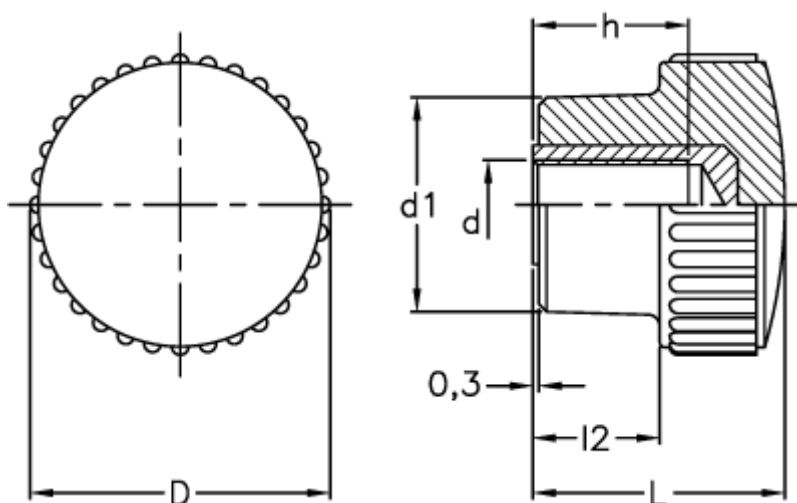

D	= 31
d1	= 19
d 6H	= M8
h	= 20
L	= 32
l2	= 17